

MOZNIČARKA  
KM 6-2 Tpts TWD

# ГЛАВНЫЙ КОНТАКТ

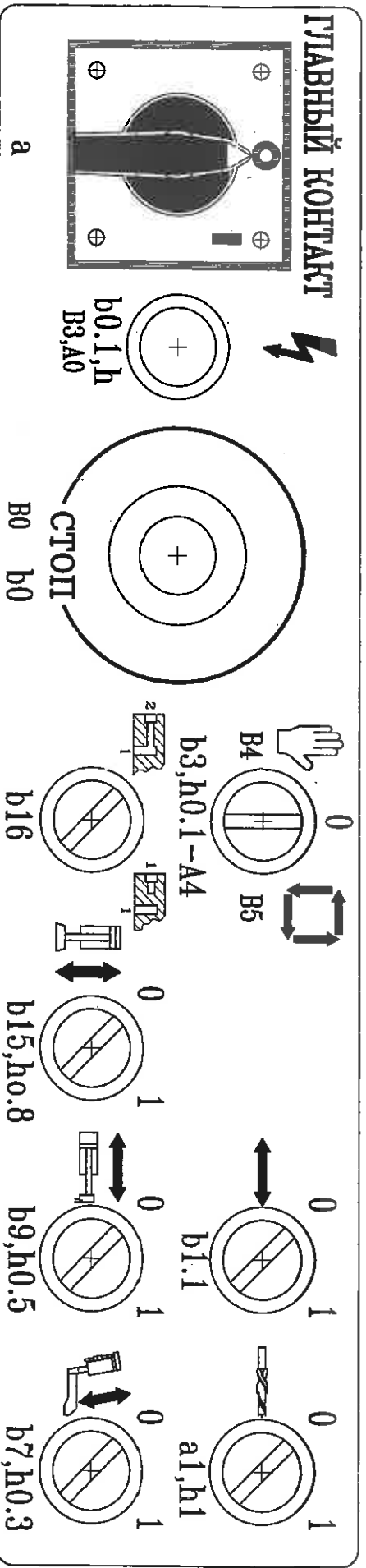

Селне placevina KM 6 - 2 T hor.f.

B19, A3

B12, A3

B10, A3

# SPREDAJ ZGORAJ

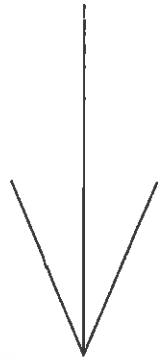

CelplikM6-2 Třmsd 1 ž.premični sup.

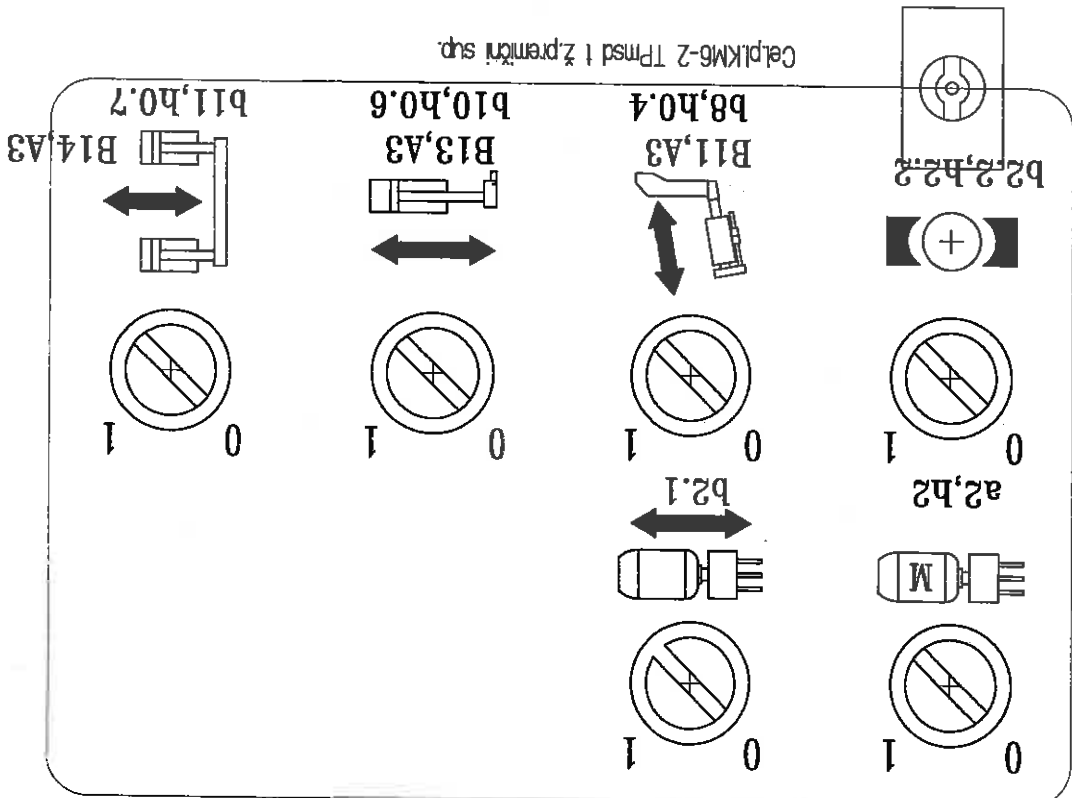

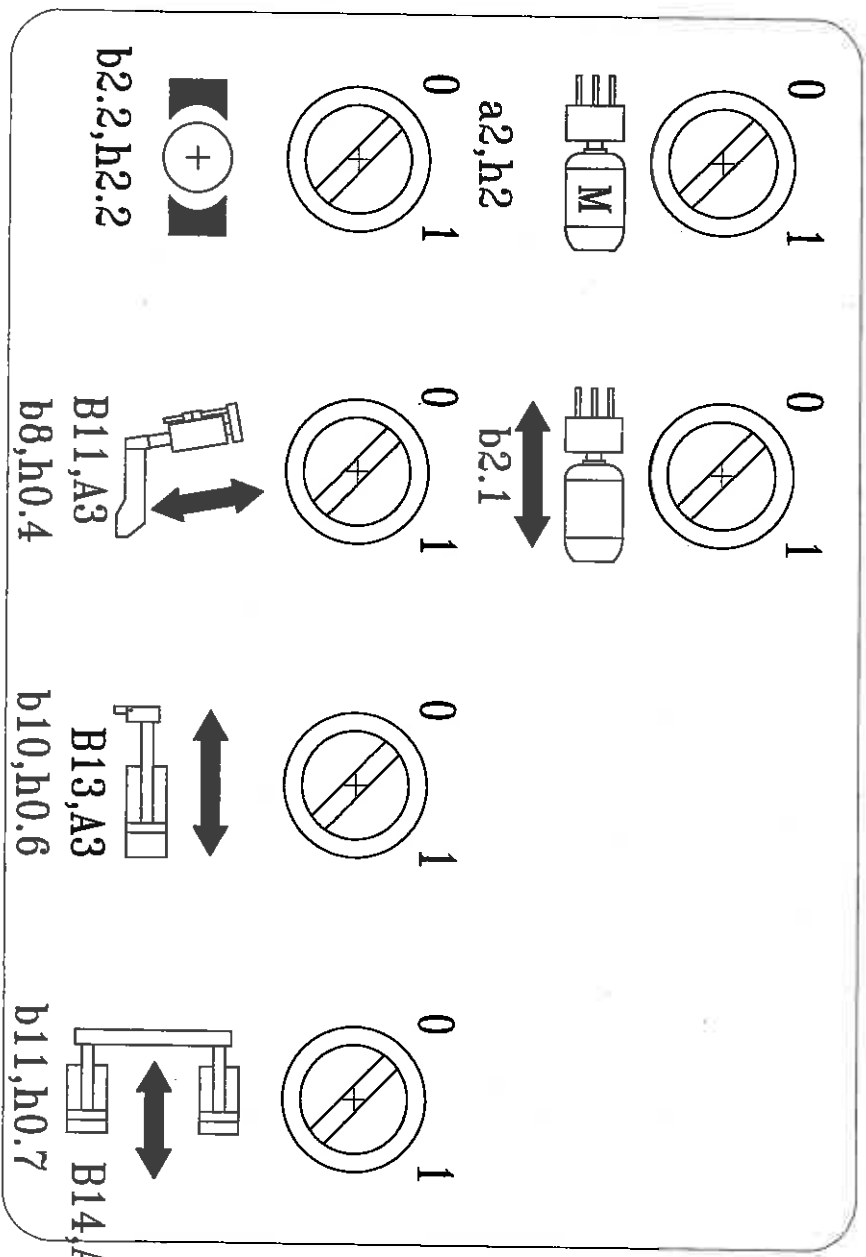

Cel.pl./KM6-2 TPs TWD CE preničri sup.

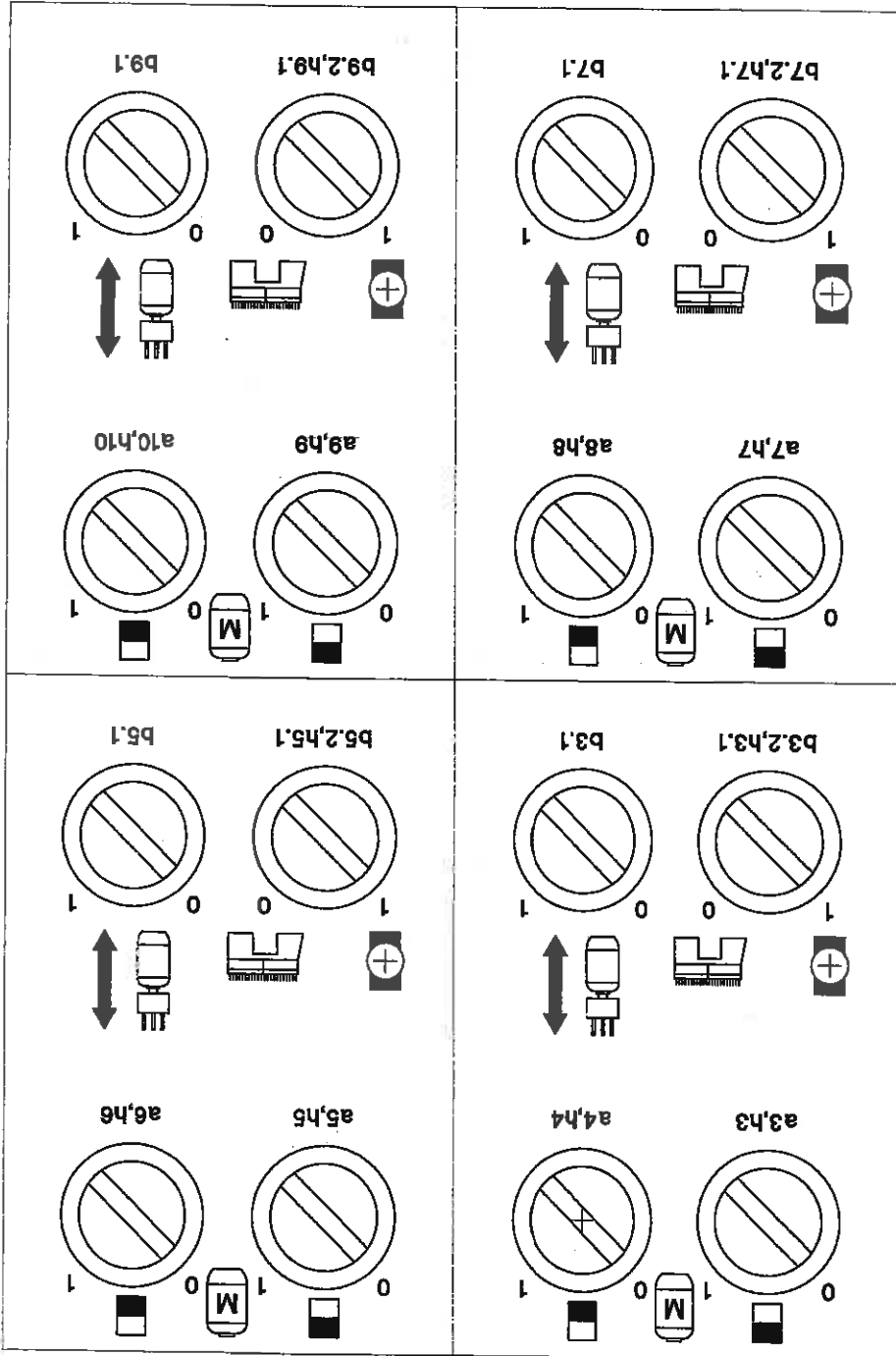

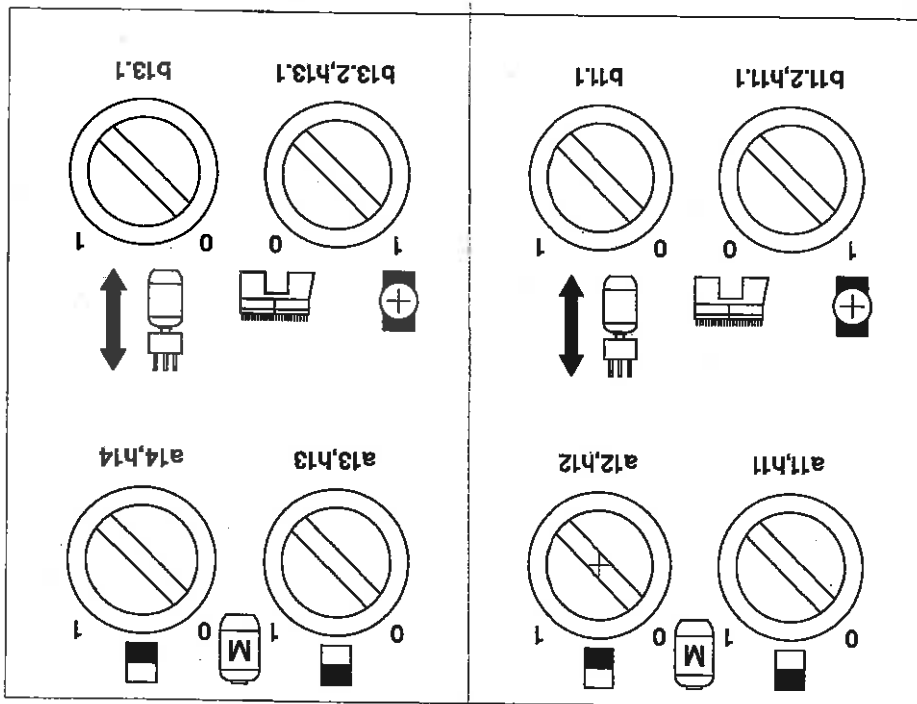

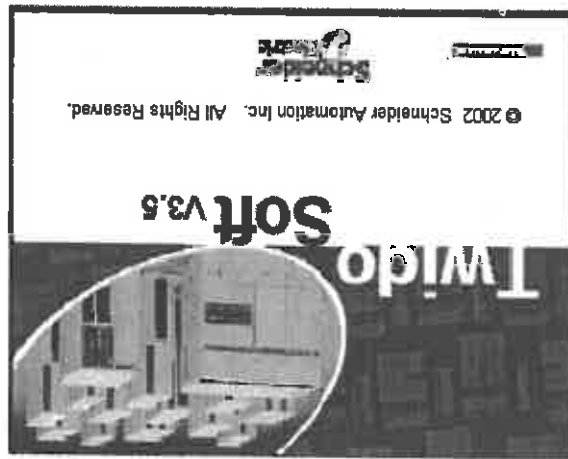

**TwidoSoft**  
**DETEL**

Program information

Print date 10/06/2008

Author Marko Cuk

Department Konstrukcija

Target TWDLMDA20DRT

Index 670538

Industrial property DN:403018

Comments

DETEL STROJEGRADNJA, Logatec, d.o.o.  
1370 Logatec, Tovarniška 36, SLOVENIJA

www.wlw.si/detel.strojegradnja  
e-mail: marko.cuk@detel-strojegradnja.si



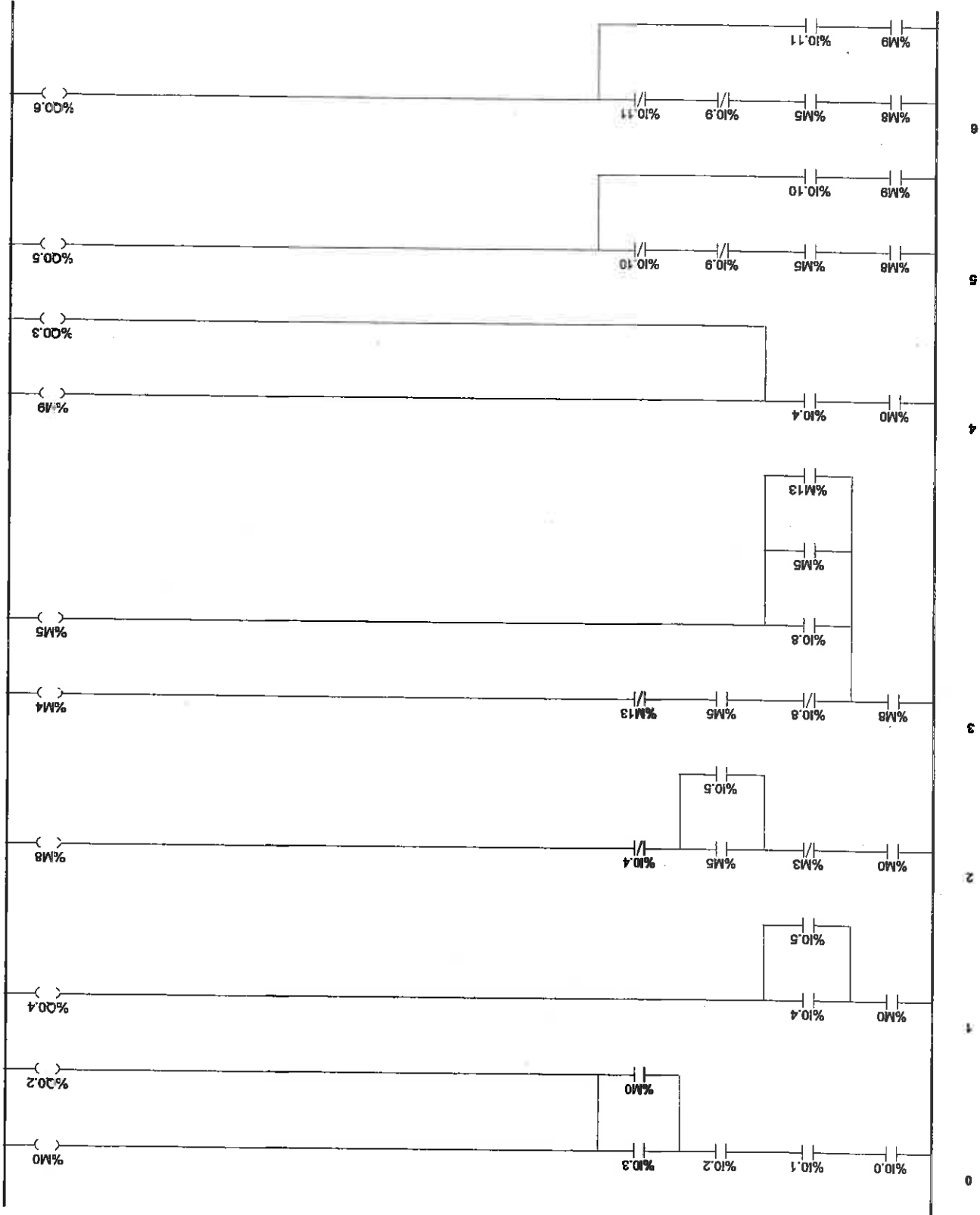

Ladder Diagram

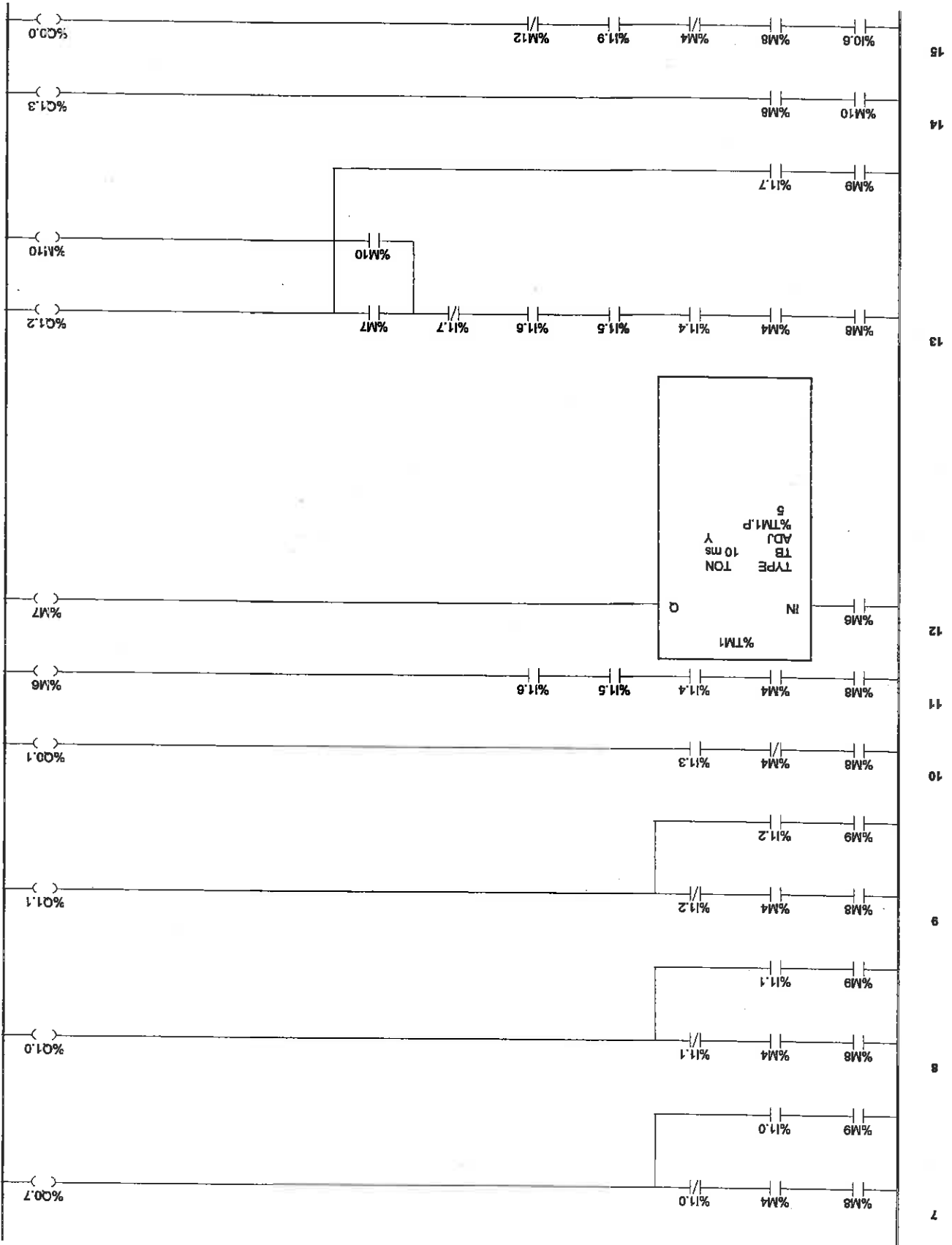

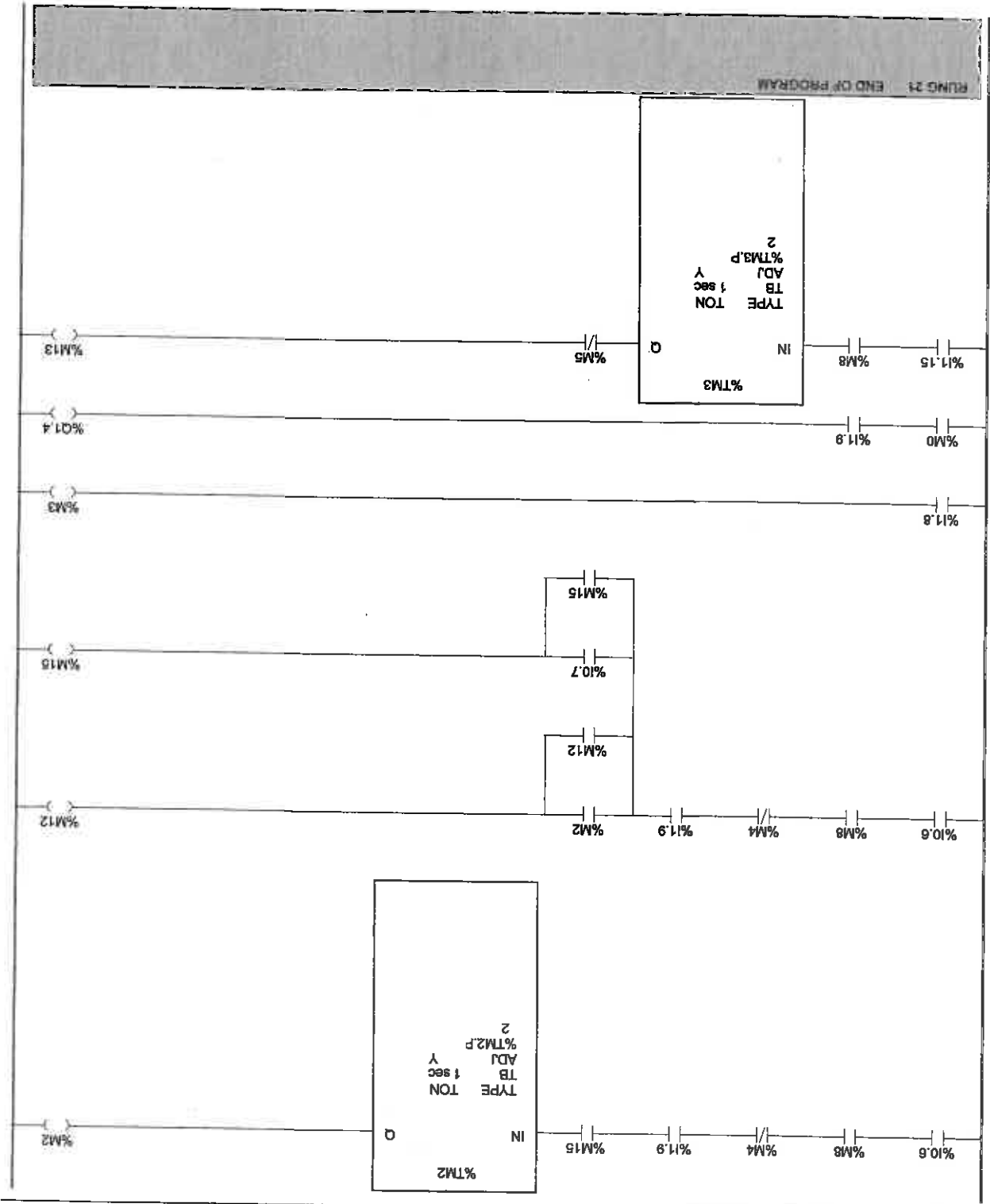

# TWD LMDA 20 DRT TELEMECANIQUE

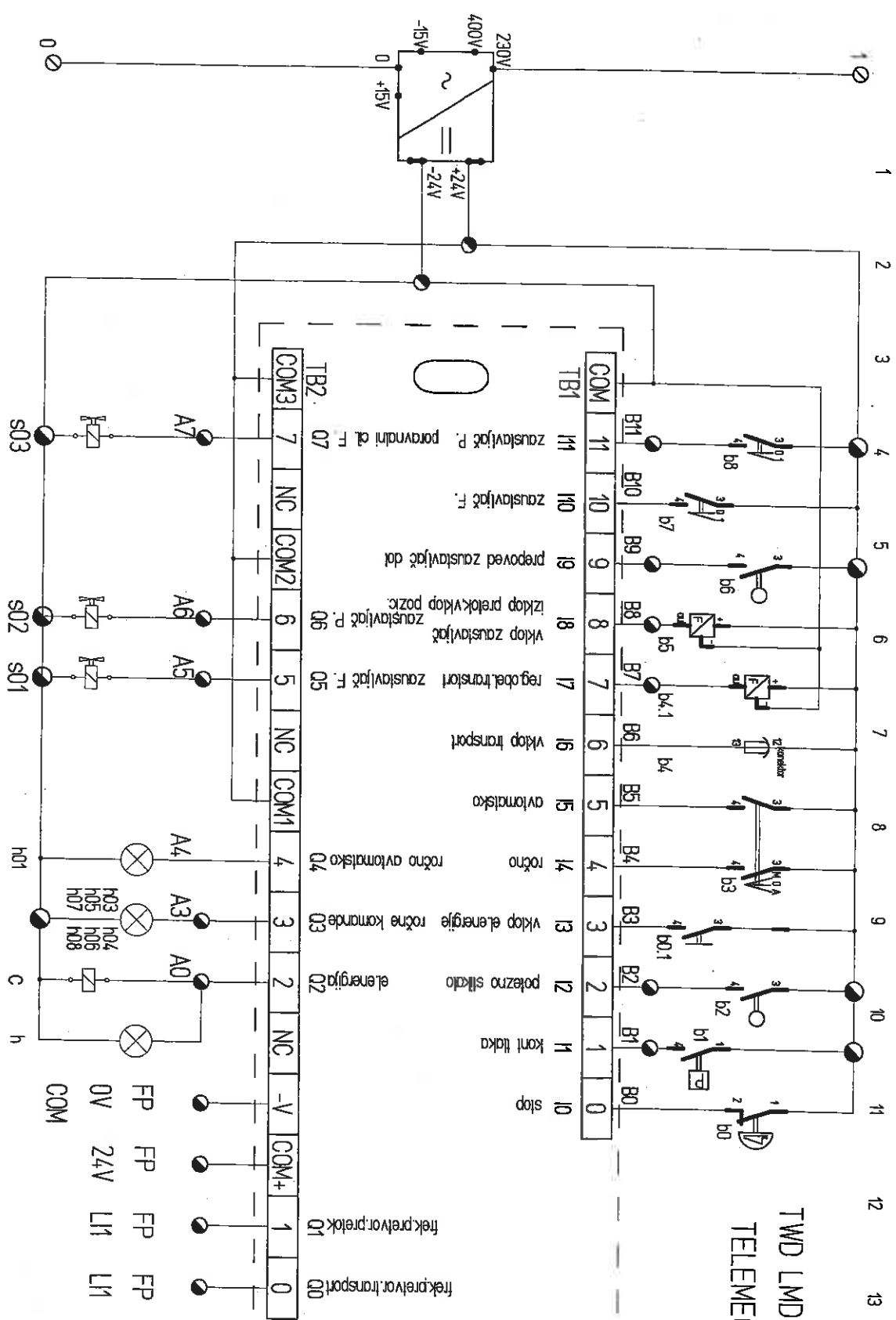

Datum	9.Maj.2008	Podpis
Konstruirani	Milko Cik	
Preledeni	Mirko Cik	
Odobreni		

Naзив: Tokovna shema  
Current scheme  
KM 6-2 TPls TWD

TWD DMM 24 DRF

TELEMECANIQUE

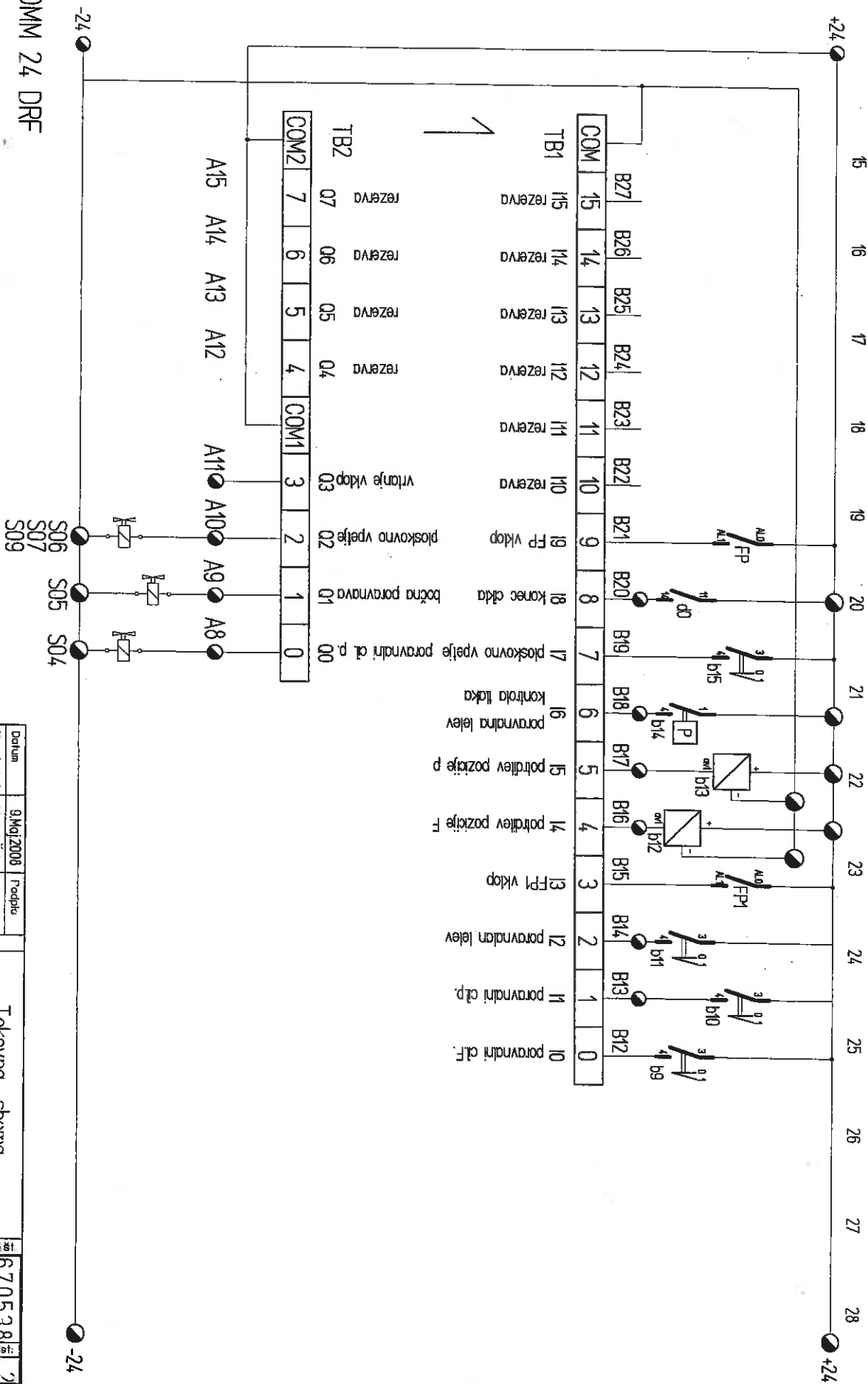

Datum	9.Maj.2008	Podpis
Konstruiral	Miroslav Čuk	
Risal	Marko Čuk	
Pregledal		
Odobril		

Naziv: Tokovna shema  
Current scheme  
KM 6-2 TPis TWD

67053812  
  
 strojeveščina

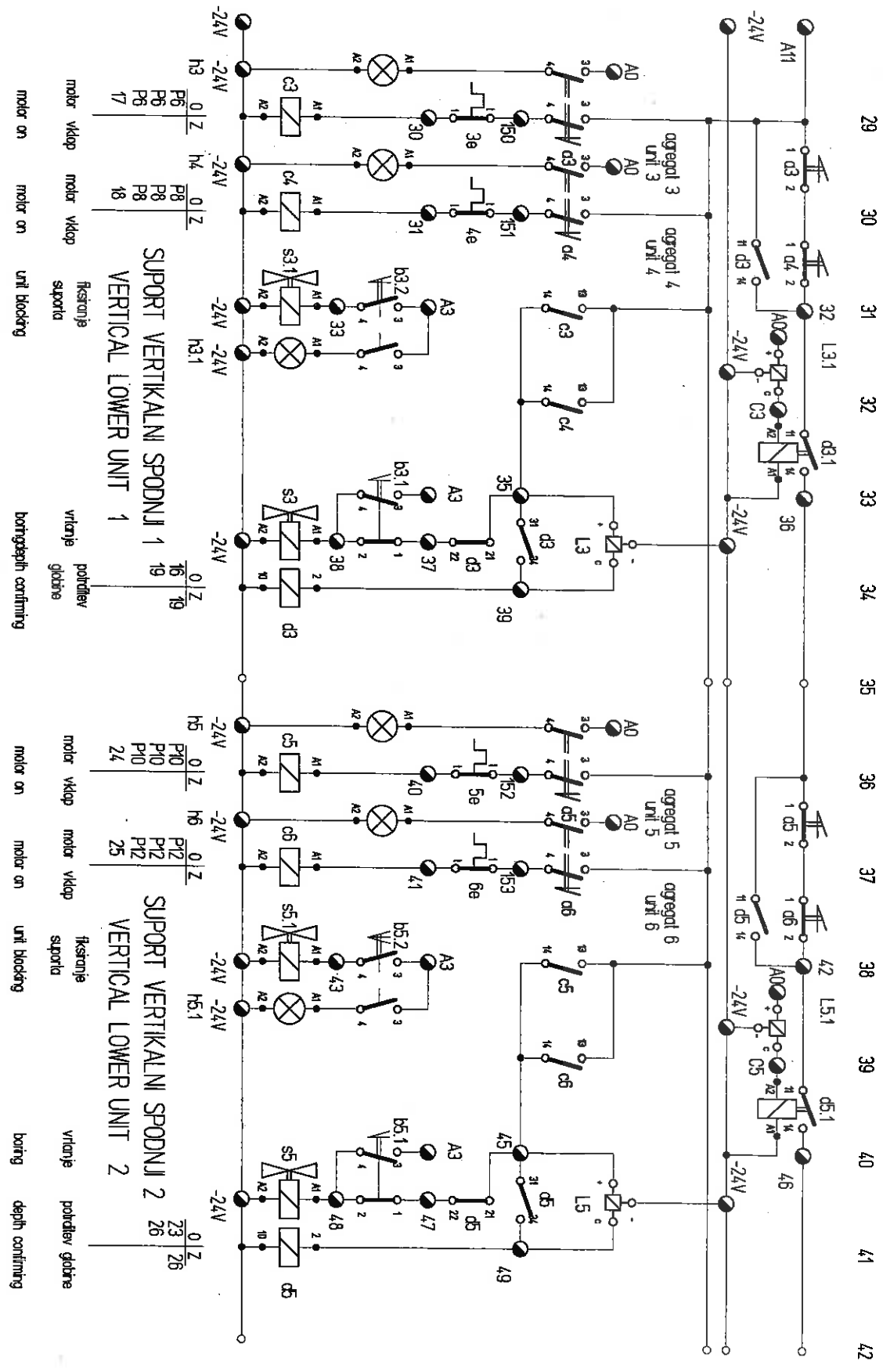

motor on      motor on      unit blocking

motor vklap      motor vklap

Ristorje  
suporta

bortagajni confirming

vrtanje      potrditev  
globine

motor on      motor on      unit blocking

motor vklap      motor vklap

fiksiranje  
suporta

boring      potrditev  
globine

SUPORT VERTIKALNI SPODNJI 1  
VERTICAL LOWER UNIT 1

SUPORT VERTIKALNI SPODNJI 2  
VERTICAL LOWER UNIT 2

Dejavnost	9.Maj.2008	Podpis:	 <b>Tokovna shema</b> <b>Current scheme</b> <b>KM 6-2 TRIs TWD</b>
Konstruiral	Marko Čuk		
Risal	Marko Čuk		
Pregledal			
Obdelal			

670538

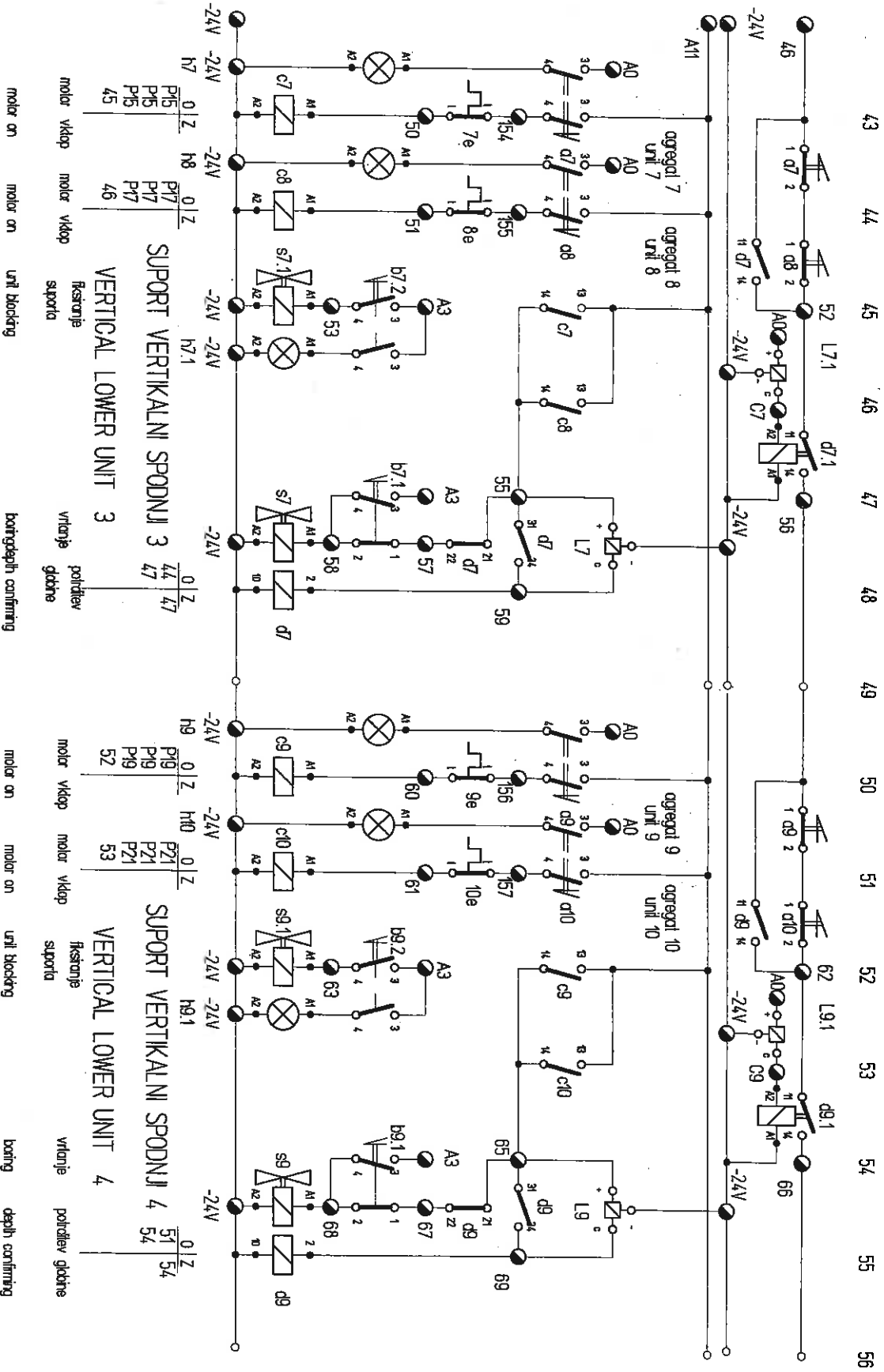

motor on    mator on    vrtnanje    vrtnanje  
 mator vkljup    mator vkljup    potrditev    potrditev  
 mator vkljup    mator vkljup    globine    globine  
 vrtnanje    vrtnanje  
 potrditev    potrditev  
 globine    globine

mator on    mator on    vrtnanje    vrtnanje  
 mator vkljup    mator vkljup    potrditev    potrditev  
 mator vkljup    mator vkljup    globine    globine  
 vrtnanje    vrtnanje  
 potrditev    potrditev  
 globine    globine

Datum	9.Maj.2008	Podpis	
Konstruiral	Marko Čuk		
Risal	Marko Čuk		
Pregledal			
Obdobje			

Tokovna shema  
Current scheme  
KM 6-2 TPis TWD

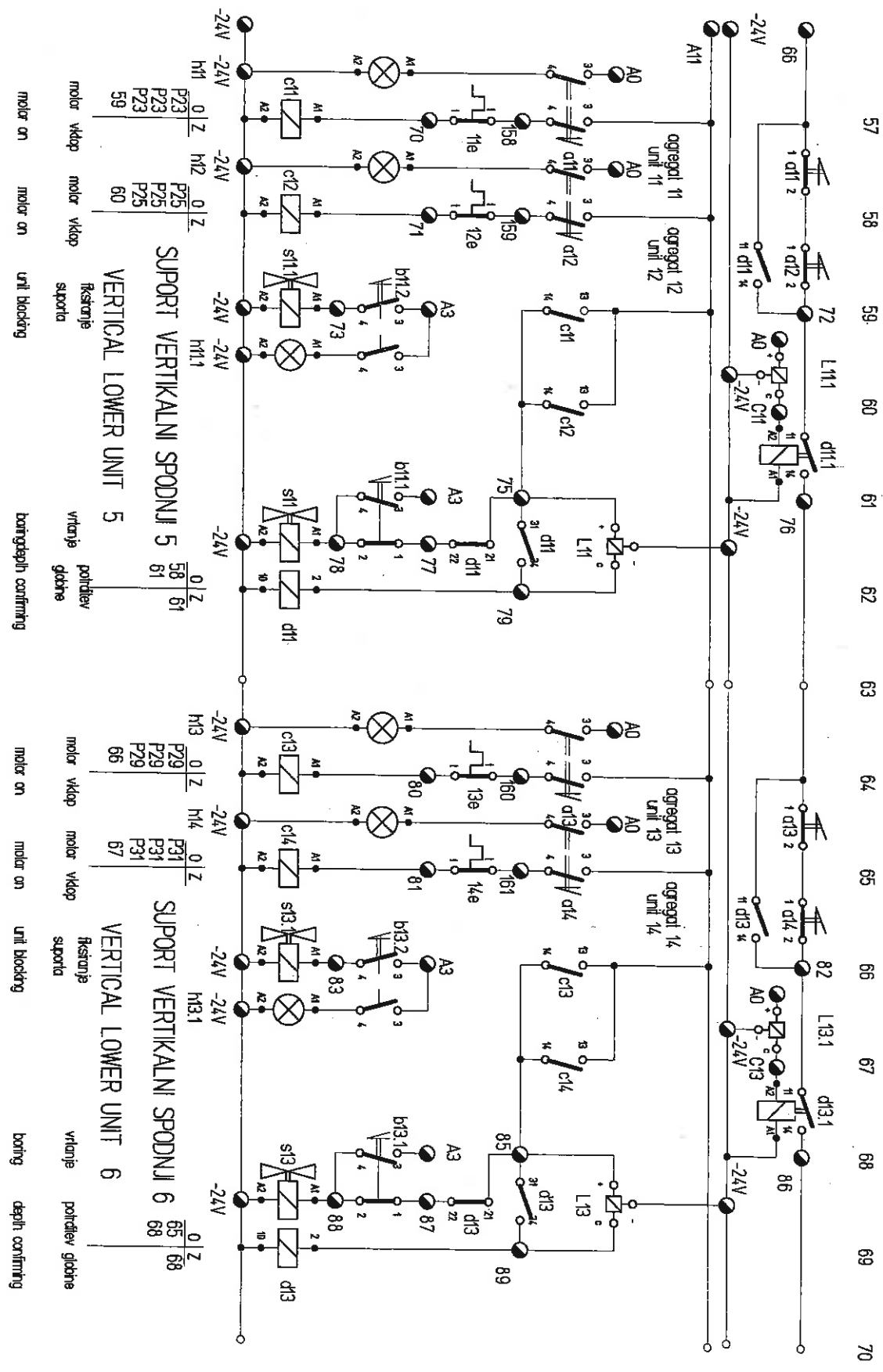

motor on      motor on      unit blocking

motor vklop      motor vklop      Rkstranje

motor on      motor on      unit blocking

motor vklop      motor vklop      Rkstranje

motor on      motor on      unit blocking

motor vklop      motor vklop      Rkstranje

motor on      motor on      unit blocking

motor vklop      motor vklop      Rkstranje

motor on      motor on      unit blocking

motor vklop      motor vklop      Rkstranje

motor on      motor on      unit blocking

motor vklop      motor vklop      Rkstranje

motor on      motor on      unit blocking

motor vklop      motor vklop      Rkstranje

motor on      motor on      unit blocking

motor vklop      motor vklop      Rkstranje

Datum	9/Maj/2008	Pačpis	
Konstruiral	Marko Čuk		
Risal	Marko Čuk		
Pregledal			
Odobril			

Tokovna shema	
Current scheme	
KM 6-2 TPis TWD	

670538	5
--------	---





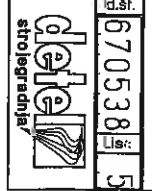

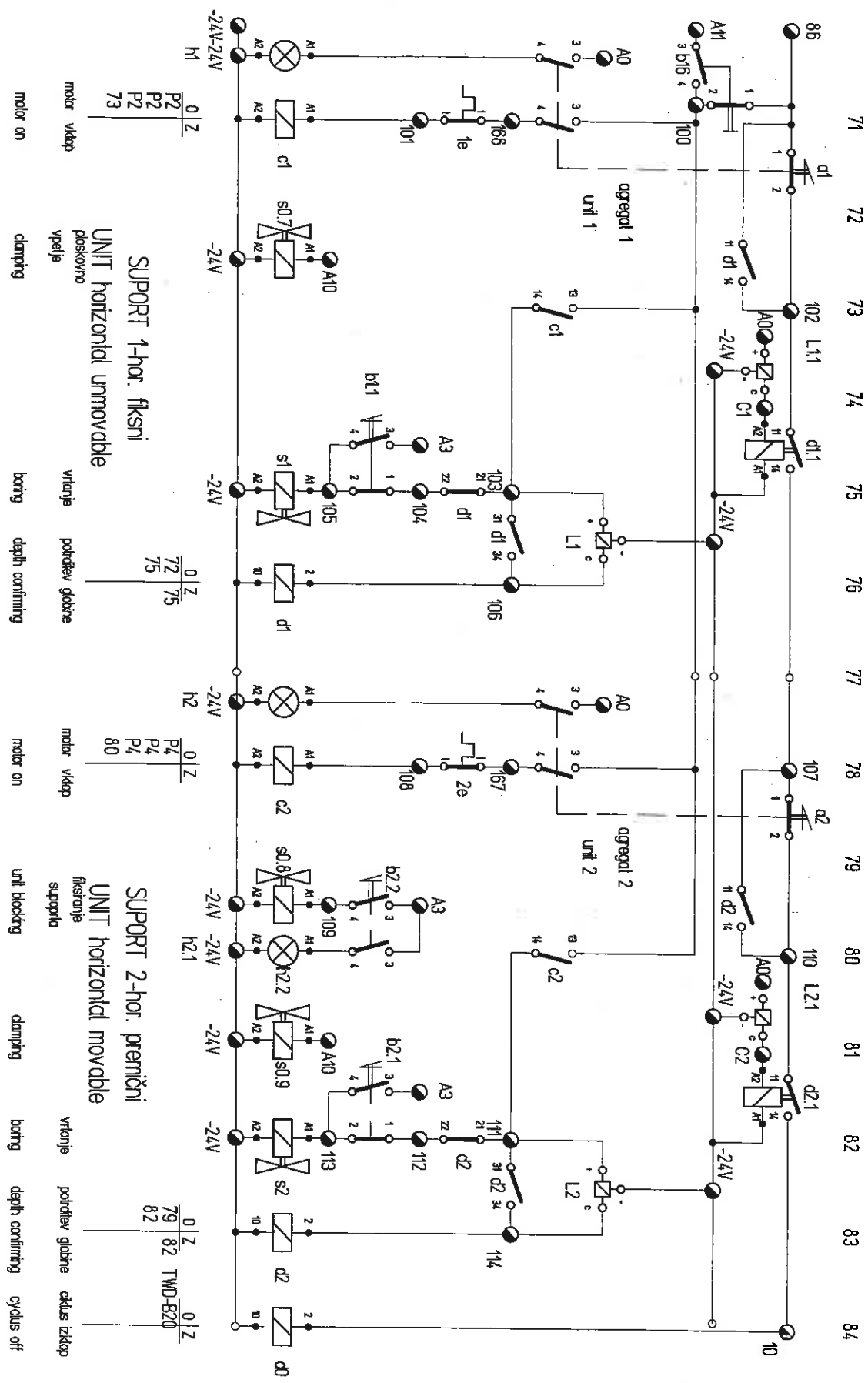
motor on  
motor vzklop

clamping  
UNIT horizontal unmovable  
poskovno  
vpejle

hoisting  
depth confirming

motor on  
motor vzklop

unit blocking  
UNIT horizontal movable  
fiksnoje  
supornje

clamping  
hoisting  
depth confirming  
cycle off

Datum	9.Maj.2008	Podpis
Konstruiral	Marko Čuk	
Risal	Marko Čuk	
Pregledal		
Odobrila		

AIZB

Tokovna shema  
Current scheme  
KM 6-2 TPis TWD

6705385	6
strojepranja	

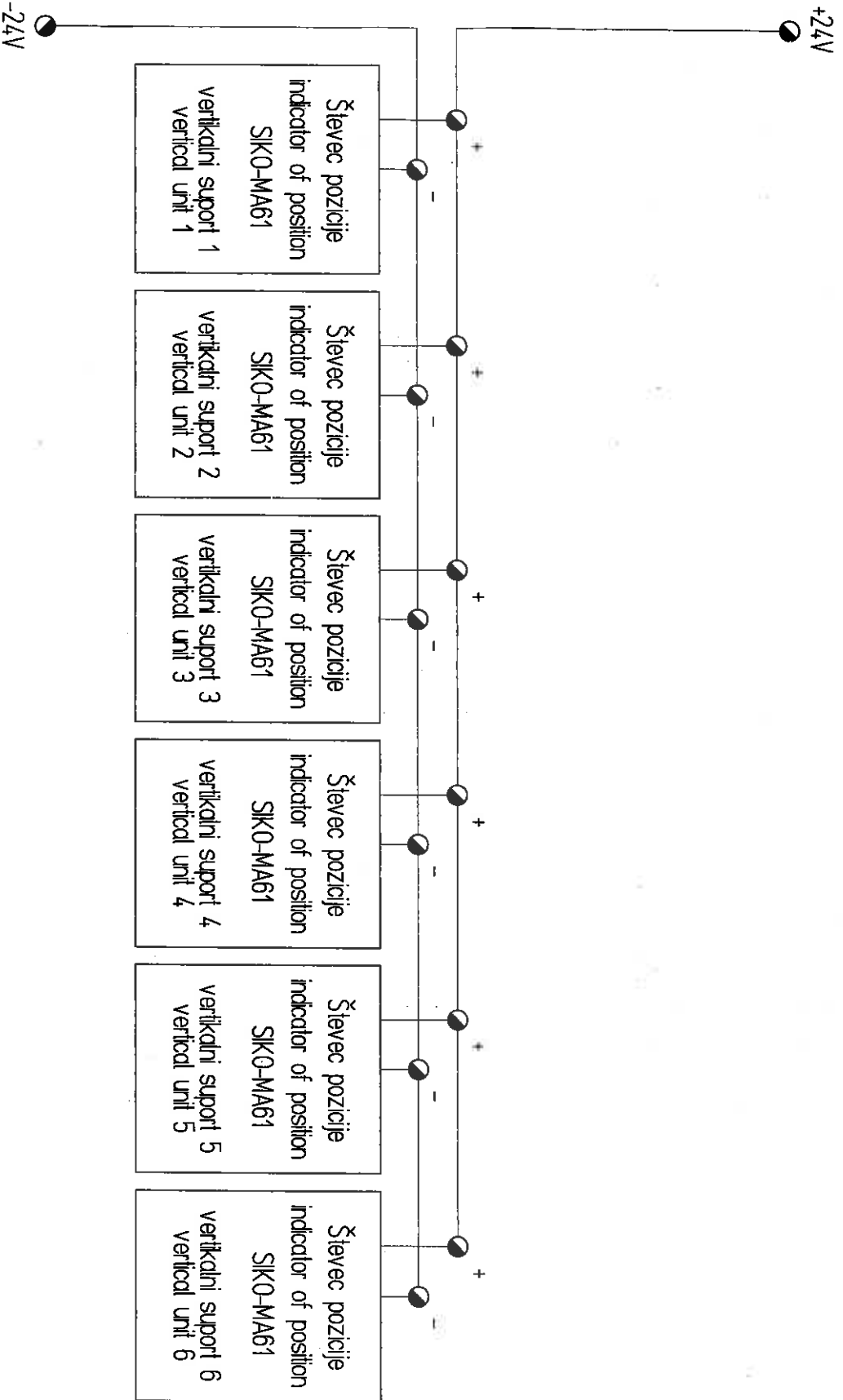

Datum	9.Maj.2008	Podpis	
Konstruiral	Marko Čuk		
Risal	Marko Čuk		
Pregledal			
Odobrtil			

Naziv  
 Tokovna shema  
 Current scheme  
 KM 6-2 TPis TWD

	Šifra	670538
	Est.	7

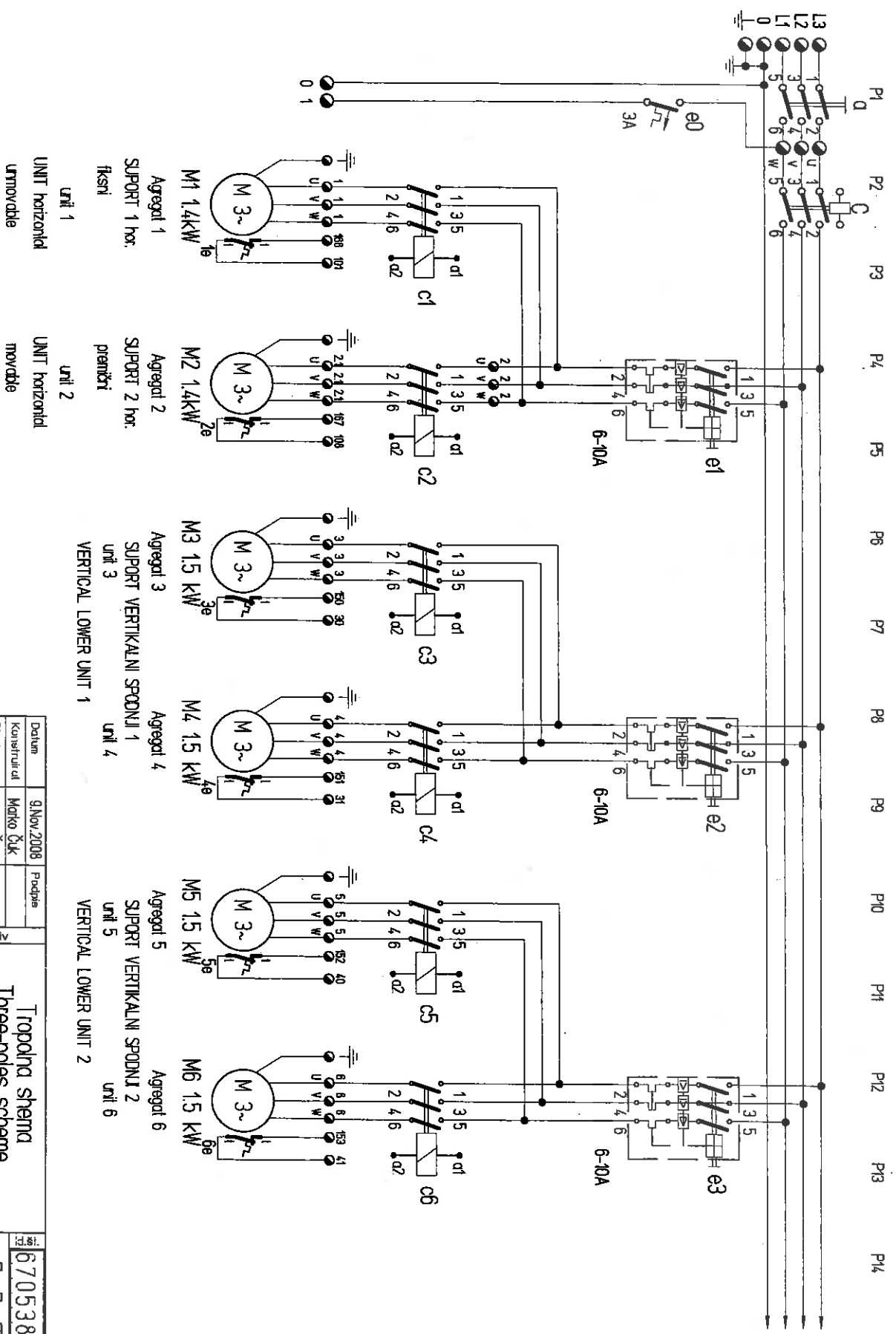

UNIT horizontal  
umovable

UNIT horizontal  
movable

Agregat 1  
SUPPORT 1 hor.  
fiksni

Agregat 2  
SUPPORT 2 hor.  
prebrzi

Agregat 3  
SUPPORT VERTIKALNI SPONJUI 1  
unit 3

Agregat 4  
SUPPORT VERTIKALNI SPONJUI 1  
unit 4

Agregat 5  
SUPPORT VERTIKALNI SPONJUI 2  
unit 5

Agregat 6  
SUPPORT VERTIKALNI SPONJUI 2  
unit 6

VERTICAL LOWER UNIT 1

VERTICAL LOWER UNIT 2

Datum	9.Nov.2008	Projepe
Konstruiral	Marko Čuk	
Risal	Marko Čuk	
Pregledal		
Odobrila		

trojpolna shema  
Three-poles scheme  
KM 6-2 TPis TWD

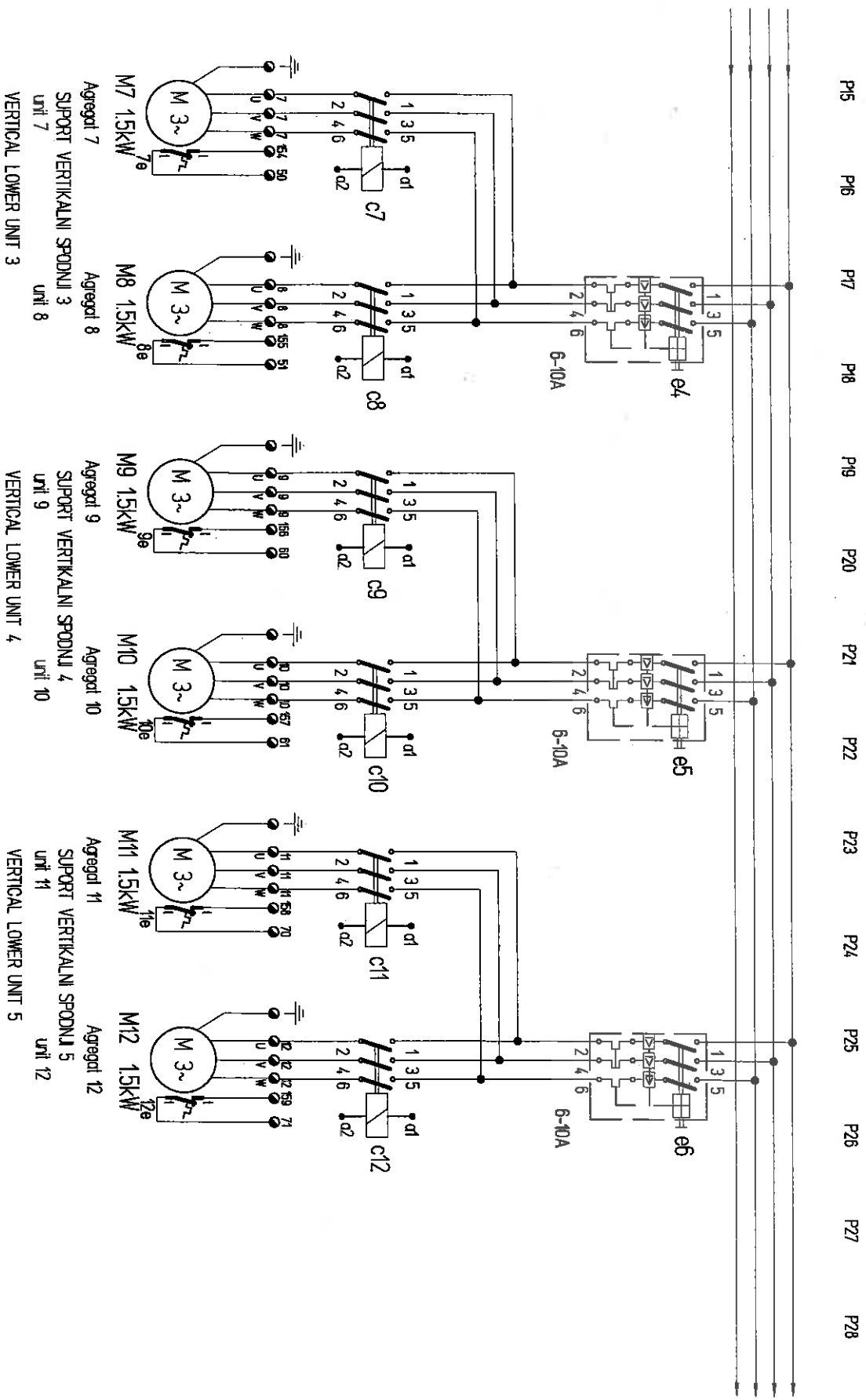

Agregat 7  
SUPPORT VERTIKALNI SPODNJI 3  
Unit 7  
VERTICAL LOWER UNIT 3

Agregat 8  
SUPPORT VERTIKALNI SPODNJI 3  
Unit 8  
VERTICAL LOWER UNIT 3

Agregat 9  
SUPPORT VERTIKALNI SPODNJI 4  
Unit 9  
VERTICAL LOWER UNIT 4

Agregat 10  
SUPPORT VERTIKALNI SPODNJI 4  
Unit 10  
VERTICAL LOWER UNIT 4

Agregat 11  
SUPPORT VERTIKALNI SPODNJI 5  
Unit 11  
VERTICAL LOWER UNIT 5

Agregat 12  
SUPPORT VERTIKALNI SPODNJI 5  
Unit 12  
VERTICAL LOWER UNIT 5

Datum	9. Nov 2008	Prizpis	Troipolna shema Three-poles scheme KM 6-2 TPis TWD
Konstruiral	Mirko Cik		
Risal	Mirko Cik		
Prejedal			
Odobril			

67053819  
delo strojegradnje

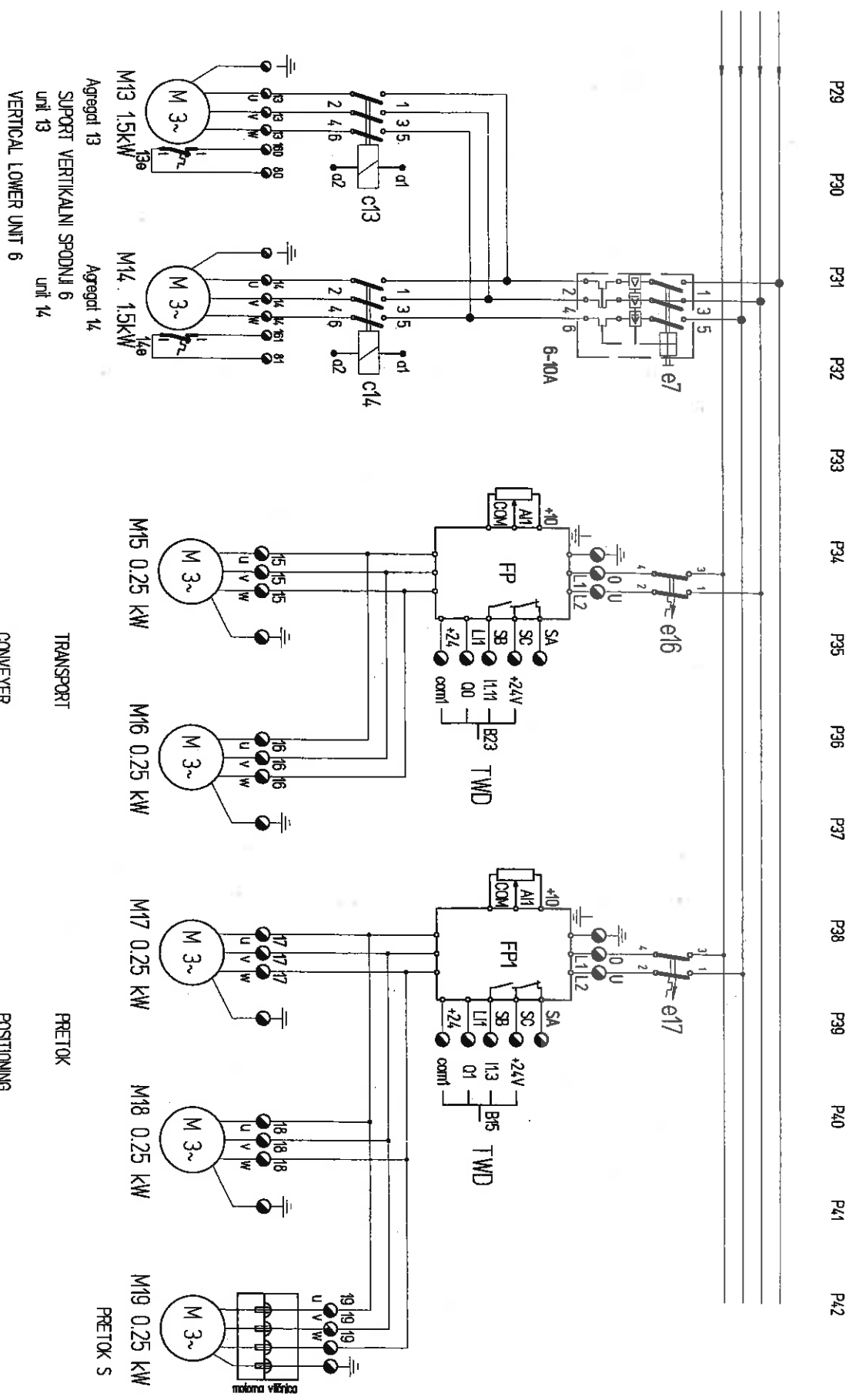

Agregat 13  
 SUPORT VERTIKALNI SPODNI 6  
 unit 13  
 VERTICAL LOWER UNIT 6

Agregat 14  
 SUPORT VERTIKALNI SPODNI 6  
 unit 14

TRANSPORT

CONVEYER

PRETOK

POSITIONING

PRETOK S

Datum	9.Maj.08	Podpis	
Konstruktivni	Mirko Cik		
Risni	Mirko Cik		
Priprema			
Odobr.			

Naziv

Tropolna shema  
KM 6-2 TPls TWD

1670538	10
---------	----

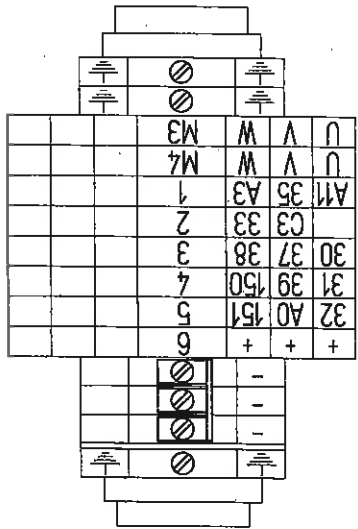

  
 Elektro strojegradnja

SUPPORT VERT. 1

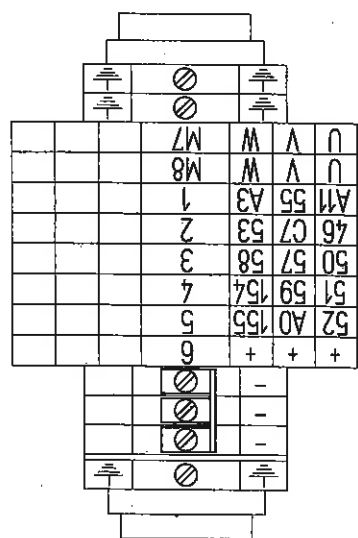

kabel	1	2	3	4	5	6	7	8	9	10	11	12	13	14	15	16	17	18	19	20	21
spolke	U	V	W	U	V	W	A11		30	31	32	35	C3	37	38	39	-	+	-	+	+
	M 3				M 4																

SUPPORT VERT.ZGOR. 3



kabel	1	2	3	4	5	6	7	8	9	10	11	12	13	14	15	16	17	18	19	20	21
spolke	U	V	W	U	V	W	A11	46	50	51	52	55	C7	57	58	59	-	+	-	+	+
	M 7				M 8																

SUPPORT VERT. 2

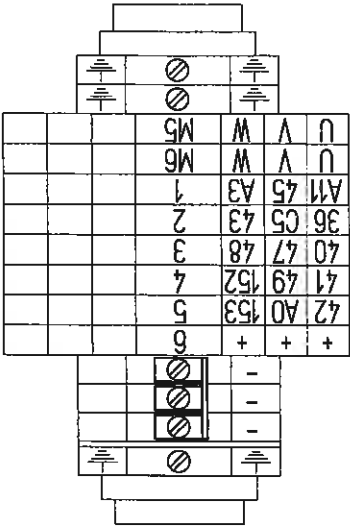

kabel	1	2	3	4	5	6	7	8	9	10	11	12	13	14	15	16	17	18	19	20	21
spolke	U	V	W	U	V	W	A11	36	40	41	42	45	C5	47	48	49	-	+	-	+	+
	M 5				M 6																

SUPPORT VERT. 4

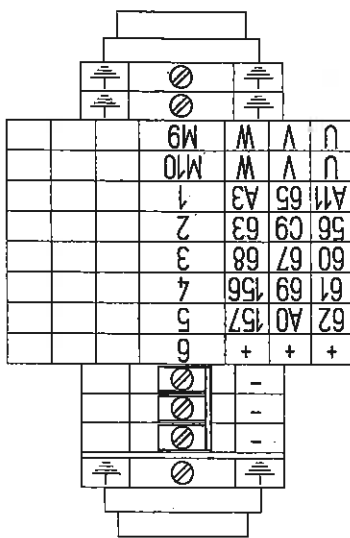

kabel	1	2	3	4	5	6	7	8	9	10	11	12	13	14	15	16	17	18	19	20	21
spolke	U	V	W	U	V	W	A11	56	60	61	62	65	C9	67	68	69	-	+	-	+	+
	M 9				M 10																

Datum	9.Maj.2008	Podpis	
Konstruiral	Marko Čuk		
Risoval	Marko Čuk		
Pregledal			
Odobril			

Tokovna shema  
Current scheme  
KM 6-2 TPIs TWD

670538/11

SUPPORT VERT. 5

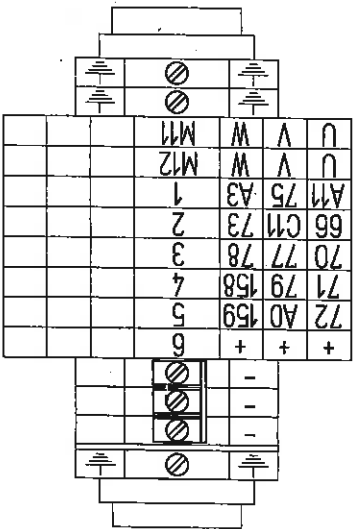

	A0	A3	A11	66	67	68	69	72	73		75	C11	77	78	79	-	+				
kabel	1	2	3	4	5	6	7	8	9	10	11	12	13	14	15	16	17	18	19	20	21
spojka	U	V	W	U	V	W	A11	66	70	71	72	75	C11	77	79	A0	A3	-	+		
	M 11																				

SUPPORT VERT. 6

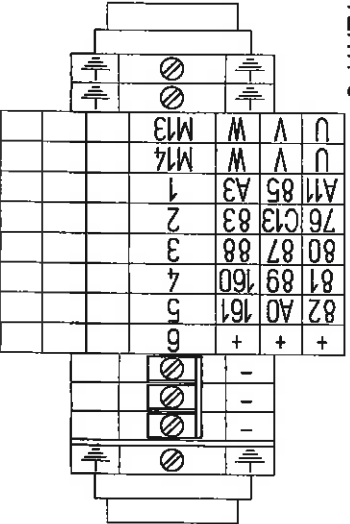

	A0	A3	A11	76	160	161	82	83		85	C13	87	88	89	-	+					
kabel	1	2	3	4	5	6	7	8	9	10	11	12	13	14	15	16	17	18	19	20	21
spojka	U	V	W	U	V	W	A11	76	80	81	82	85	C13	87	89	A0	A3	-	+		
	M 13																				

Datum	9.Maj.2008	Podpis	
Konstruirani	Marko Ćuk		
Risni	Marko Ćuk		
Pregledali			
Odobrili			

112

Tokovna shema  
Current scheme  
KM 6-2 TPis TWD



RAZPORED SPONK KM 6-2 TPis TWD

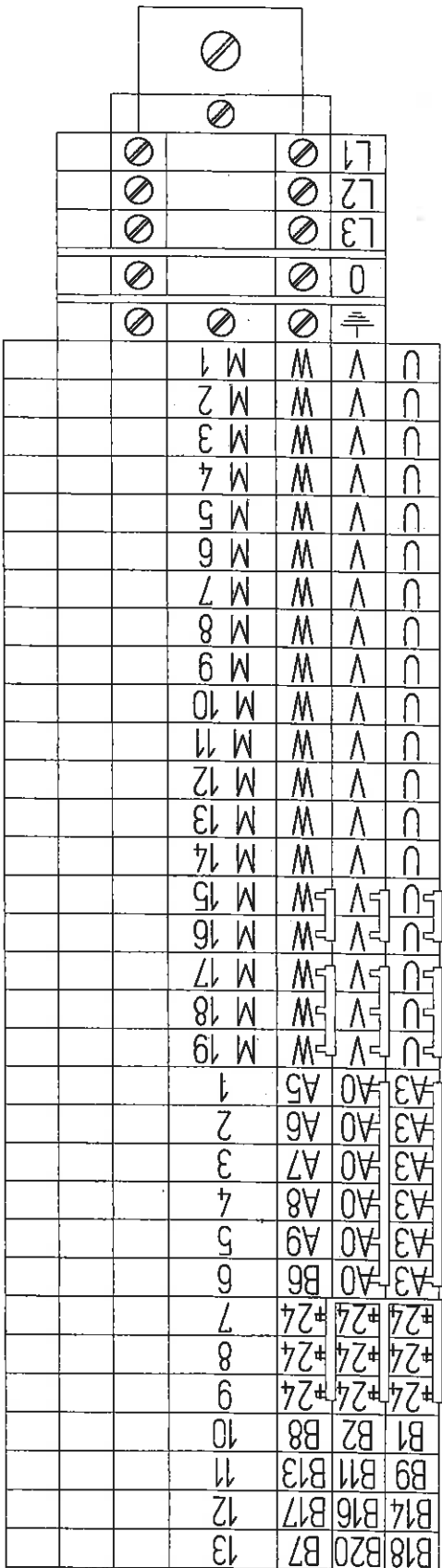

A11	A10	10	42	45	46	47	49	46	22
A11	A10	30	36	40	41	20			
A11	A10	31	36	39	37	19			
A11	A10	32	36	39	37	19			
A11	A10	35	36	40	41	20			
A11	A10	37	36	39	37	19			
A11	A10	41	36	40	41	20			
A11	A10	45	42	45	46	21			
A11	A10	46	47	49	46	22			
A11	A10	51	50	51	52	23			
A11	A10	52	55	56	57	24			
A11	A10	57	55	56	60	25			
A11	A10	60	61	62	65	26			
A11	A10	62	66	67	69	27			
A11	A10	65	66	67	69	27			
A11	A10	67	66	70	71	28			
A11	A10	70	72	76	75	29			
A11	A10	71	77	76	79	30			
A11	A10	75	80	81	82	31			
A11	A10	76	86	85	87	32			
A11	A10	81	86	89	101	33			
A11	A10	82	100	102	103	34			
A11	A10	87	100	102	105	35			
A11	A10	101	104	107	166	36			
A11	A10	103	106	107	C1	37			
A11	A10	105	C3	C5	C7	38			
A11	A10	107	C9	C11	C13	39			
A11	A10	166	-	-	-	40			
A11	A10	40	-	-	-	41			
A11	A10	41	-	-	-	42			
A11	A10	42	-	-	-	43			
A11	A10	43	-	-	-	43			

Dolžina letve 500mm

Datum	9/Maj/2008	Pradnja
Konstruiral	Mirko Čuk	
Risal	Mirko Čuk	
Pregledal		
Odobril		

Naziv  
Tokovna shema  
Current scheme  
KM 6-2 TPis TWD

Šifra: 67.0538  
Šifra: 13  
delo strojepranja



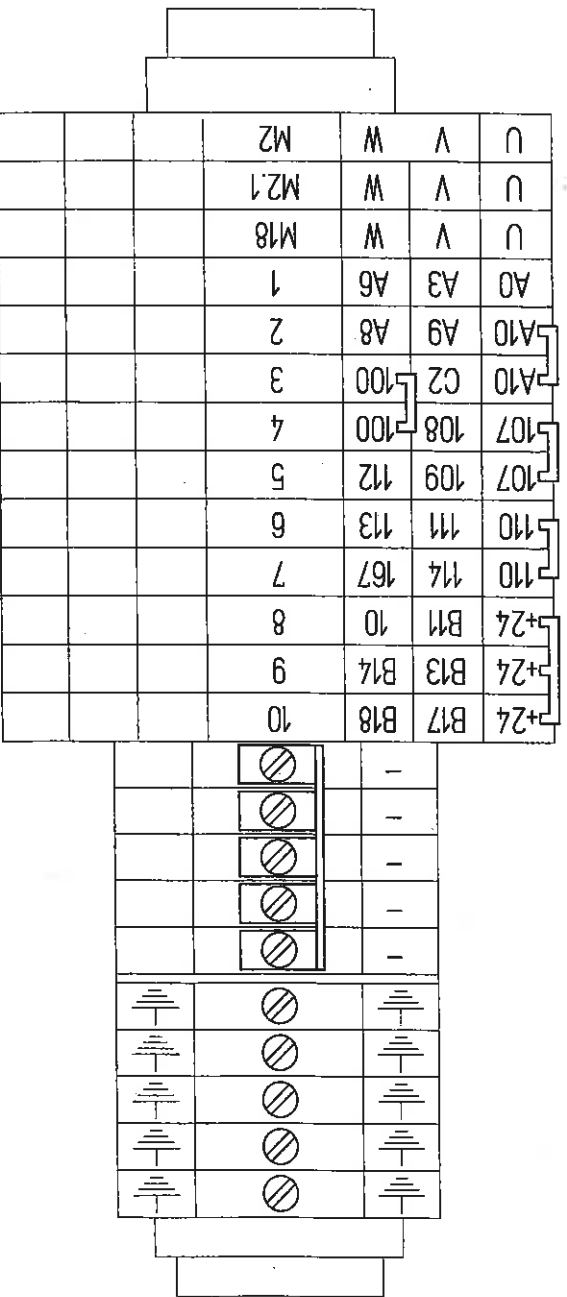

SUPPORT PREMIČNI

HOR.

Dovod omara-support

kabel SL-YY 21X1.5

1	2	3	4	5	6	7	8	9	10	11	12	13	14	15	16	17	18	19	20	21
		B11	B13	B14	B17	B18	A0	A3			A6	A8	A9	A10	C2	100	107		-	⊥

Dovod omara-support

kabel SL-YY 10X1.5

1	2	3	4	5	6	7	8	9	10
U	V	W	U	V	W				⊥
M2				M18					

spionke

spionke

povezava na čelno ploščo

-	A0	A3	+24	B11	B13	B14		100	107	109	110	112	113	167	
---	----	----	-----	-----	-----	-----	--	-----	-----	-----	-----	-----	-----	-----	--

Datum	9.Maj.2008	Podpis		Tokovna shema	670538
Konstruiral	Marko Čuk			Current scheme	14
Risal	Marko Čuk			KM 6-2 TPs TWD	
Prejelci					
Odobril					



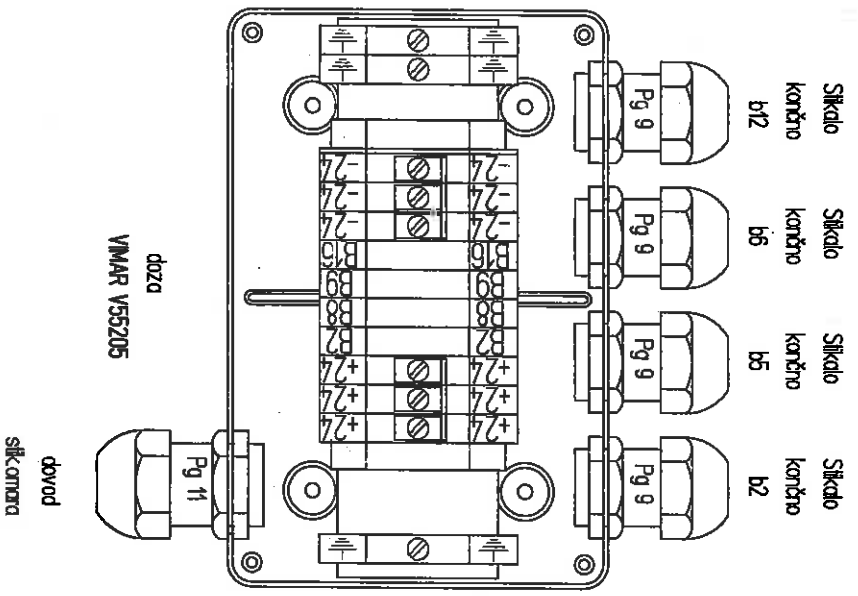

POVEZAVNA STIKAL VZGORNEM NOSILCU

kabel SL-YY 7X0.75

KABEL	1	2	3	4	5	6	7
SPONKE	+24	B2	B8	B9	B16	-24	⏏

Datum	9/Maj/2008	Podpis	
Konstruiral	Miroslav Čuk		
Risal	Miroslav Čuk		
Prejela			
Odobrila			
Naziv			
Tokovna shema Current scheme KM 6-2 TPis TWD			
670538		15	

Podpis	9. Maj 2008	Marko Čuk	Marko Čuk	Risal	Pregledal	Odobril
Datum						
Konstruiral						
Naziv						

Tropolna shema  
Three-poles scheme  
KM 6-2 TPs TWD

Id. št.	670538
Lista	16

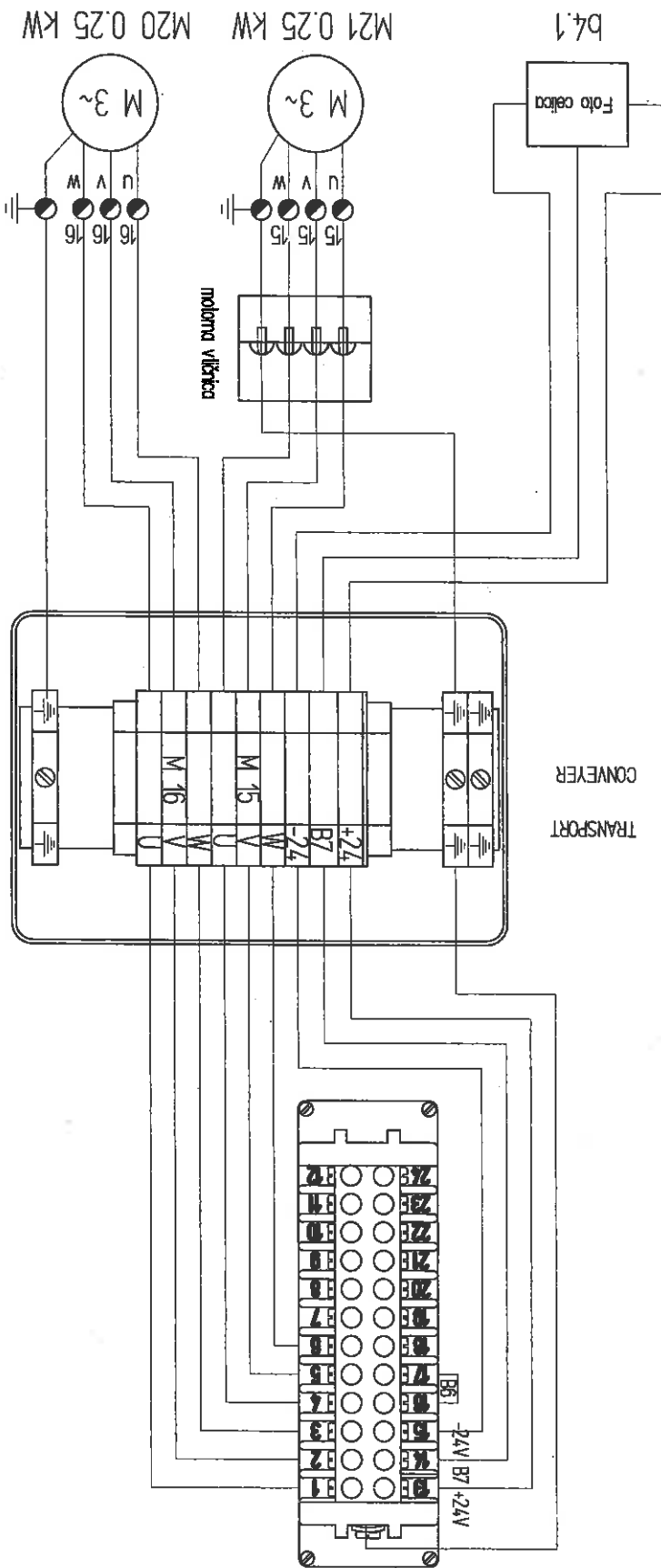

kabel	1	2	3	4	5	6	7	8	9	10	11	12	13	14
sponke	U	V	W	U	V	W			+24	B7	-24			
	M 15			M 16										

Kabel do konektorja

POZ.	IDENT	NAZIV	ENOTA	KOLIČINA
1	600468	ZICA PF 1,5	MI	10
2	607755	UVODNICA PVC 9 RAVNA	KOS	1
3	607757	UVODNICA PVC 16 RAVNA	KOS	2
4	608931	LETEV AMI-DP 200	KOS	2
5	608873	PRTRIDITEV KONČNA ABI-AB8P3	KOS	16
6	608899	ELEMENT STKALA V1	KOS	1
7	608983	POKROV AK2-CD75	KOS	1
8	608984	KANAL AK2-GD7550	KOS	1
9	608985	POKROV AK2-CD37	KOS	1
10	608986	KANAL AK2-GD3750	KOS	1
11	608987	POKROV AK2-CD25	KOS	1
12	608988	KANAL AK2-GD2550	KOS	1
13	608989	SPONKA ABI-VV435U	KOS	1
14	608990	SPONKA N.ABI-VV435UBL	KOS	30
15	608991	SPONKA OZ.ABI-TP435U	KOS	10
16	608992	SPONKA ABI-VV1035U	KOS	10
17	608993	SPONKA N.ABI-VV1035UBL	KOS	3
18	608994	SPONKA OZ.ABI-TP1035U	KOS	1
19	600473	ZICA PF 0,75	MI	1
20	608335	KABEL YSLY 3 X 0,75	MI	200
21	608592	TULEC DZ5 CE 007	KOS	5
22	608594	TULEC DZ 5 CE 015	KOS	500
23	610772	STIKALO KONČNO TELO ZCMD 21 L2	KOS	400
24	610321	ZBIRALKA GV-2G445	KOS	1
25	610745	SENZOR IND.XS512B1PAM12	KOS	2
26	610773	STIKALO KONČNO GLAVA ZCE 01	KOS	2
27	610774	STIKALO KONČNO TIPALO ZCY 44	KOS	1
28	608982	SPONKA VRSTNA TRO.ABI-ET32 35U	KOS	1
29	609451	VAROVALKA GB2CB08	KOS	2
30	609493	VAROVALKA AVT.GB2CD14	KOS	2
31	609041	DOZA 120-80-50	KOS	1
32	610868	FOTOCELICA XUB0APSNM12	KOS	1
33	610913	NAPISNA PLOŠČICA RXZ1420	KOS	1
34	610891	PODNOZJE RELEJA RXZEZM114M	KOS	1
35	609720	TIPKA RDEČA ZB4BK1343 1-0-2	KOS	1
36	609781	TIPKA -RDEČA ZB4BW0B41	KOS	1
37	609706	TIPKA PREK. SVET.RUMENA ZB4BK1253	KOS	1
38	609897	TIPKA ZB4BW0B51	KOS	3
39	609657	TIPKA ZB4BD2	KOS	3
40	609654	TIPKA ZB4BW33	KOS	1
41	609708	ELEMENT TIPKE Z LUČKO ZB4BW0B35 24V	KOS	1
42	609680	ELEMENT ZB4BZ102	KOS	1
43	610820	STIKALO VARNOSTNO XY2CH13270	KOS	1
44	610890	RELE RXM4AB2BD	KOS	1
45	610925	FREKVENČNI PRETVORNIK FR-S520SE	KOS	1
46	609574	STIKALO ROČICA KCF1PZ	KOS	1
47	610712	PROGRAMATOR TWD LMDA 20 DRT	KOS	1
48	609678	TIPKA ZB4B554	KOS	1
49	670503	E.L.OPREMA HOR.SUP.F.KM TPTS TWD	KOS	1
50	609808	KABEL Z KONJEKTOR XZCP12411S	KOS	2
51	609659	ELEMENT ZBE101	KOS	2
52	610064	KONTAKTOR LCID25BD	KOS	1
53	610771	NAPAJALEC ABL-7RE 2405	KOS	1
54	670504	E.L.OPREMA HOR.SUP.F.KM TPTS TWD	KOS	1
55	610022	KABEL S KONJEKTORJEM XZCP11411S	KOS	1
56	609819	KONTAKTOR LPIK0910BD	KOS	1
57	610714	RAZŠIRITEV 16V-8IR TWD DMM 24 DRF	KOS	1

Detel Strojevradnja Logatec, d.o.o.

12.6.2008

EL.OPREMA KM 6-2 TPTS TWD

IDENT:

670538

POZ	IDENT	NAZIV	ENOTA	KOLICINA
58	670505	EL.OPREMA VERT.SUP.KM TPTS TWD	KOS	6
59	670090	EL.OPREMA KM TRANSPORT SP.NC.CE.S.	KOS	1

POZ	IDENT	NAZIV	ENOTA	KOLIČINA
1	609454	UVODNICA PG 7 - FI 8	KOS	2
2	609453	CEV GIBLI ZAŠČITNA PVC FI 8	M	2
3	609707	TIPKA PREK. SVET.ZELENA ZB4BK1233	KOS	1
4	609657	TIPKA ZB4BD2	KOS	1
5	608483	KABEL YSLY 10X1,5	MI	3
6	609708	ELEMENT TIPKE Z LUČKO ZB4BW0B35 24V	KOS	1
7	609819	KONTAKTOR LP1K0910BD	KOS	1
8	610276	SENZOR IND. XS1N08PA349	KOS	2
9	609659	ELEMENT ZBE101	KOS	2
10	609658	ELEMENT ZBE102	KOS	1
11	608939	STIKALO ZAŠČITNO GV2-ME14	KOS	1
12	610891	PODNOZJE RELEJA RXZE2M114M	KOS	1
13	610890	RELE RXM4AB2BD	KOS	1
14	609637	ELEMENT TIPKE ZB4BZ101	KOS	1
15	609554	CEV GIBLI ZAŠČITNA PVC FI 14	M	15
16	609544	UVODNICA PG 13,5 - FI 14	KOS	2
17	609704	EL.MOTOR 2TAN 80 BB2 IM B14 ET POS.	KOS	1
18	610370	RELE ABR2S112B	KOS	1
19	610342	NOSILEC SENZORIJA FI 8 XSZB108	KOS	2
20	610913	NAPISNA PLOŠČICA RXZ1420	KOS	1

POZ	IDENT	NAZIV	ENOTA	KOLIČINA
1	600345	MATICA OG 21	KOS	1
2	600629	UVODNICA OG 21	KOS	1
3	609659	ELEMENT ZBE101	KOS	4
4	607755	UVODNICA PVC 9 RAVNA	KOS	1
5	607756	UVODNICA PVC 13,5 RAVNA	KOS	1
6	607758	MATICA PVC 9	KOS	1
7	607759	MATICA PVC 13,5	KOS	1
8	609707	TIPKA PREK. SVET.ZELENA ZB4BK1233	KOS	1
9	609706	TIPKA PREK. SVET.RUMENA ZB4BK1253	KOS	3
10	608485	KABEL YSLY 25X1,5	MI	8
11	609657	TIPKA ZB4BD2	KOS	1
12	608873	PRITRIDITEV KONČNA ABI-AB8P35	KOS	4
13	609819	KONTAKTOR LPIK0910BD	KOS	1
14	608982	SPONKA VRSTNA TRO. ABI-ET32 35U	KOS	17
15	608990	SPONKA N.ABI-VV435UBL	KOS	6
16	608991	SPONKA OZ.ABI-TP435U	KOS	6
17	609637	ELEMENT TIPKE ZB4BZ101	KOS	1
18	610276	SENZOR IND. XS1N08PA349	KOS	2
19	609658	ELEMENT ZBE102	KOS	1
20	609743	TIPKA PREKLOPNA RDEČA ZB4BK1243	KOS	1
21	609708	ELEMENT TIPKE Z LUČKO ZB4BW0B35 24V	KOS	1
22	609781	TIPKA-RDEČA ZB4BW0B41	KOS	1
23	610891	PODNOŽJE RELEJA RXZE2M114M	KOS	1
24	610890	RELE RXM4AB2BD	KOS	1
25	609897	TIPKA ZB4BW0B51	KOS	3
26	609454	UVODNICA PG 7 - FI 8	KOS	2
27	609453	CEV GIBLI ZAŠČITNA PVC FI 8	M	2
28	609554	CEV GIBLI ZAŠČITNA PVC FI 14	M	2
29	609544	UVODNICA PG 13,5 - FI 14	KOS	1
30	609406	CEV GIBLI ZAŠČITNA PVC FI 10	MI	3
31	610913	NAPISNA PLOŠČICA RXZL420	KOS	1
32	610370	RELE ABR2S112B	KOS	1
33	610342	NOSILEC SENZORJA FI 8 XSZB108	KOS	2
34	610477	PLOŠČA MONTAZNA MM43	KOS	1
35	609704	EL.MOTOR 2TAN 80 BB2 IM B14 ET POS.	KOS	1
36	607757	UVODNICA PVC 16 RAVNA	KOS	2
37	607760	MATICA PVC 16	KOS	2
38	607973	UVODNICA PVC 11 RAVNA	KOS	1
39	607974	MATICA PVC OG 11	KOS	1
40	607733	UVODNICA PVC PG 7	KOS	10
41	607732	MATICA PVC RE 7	KOS	10
43	610476	OMARICA PL. CRN 43150 400X300X150	KOS	1

Detel Strojegradnja Logatec, d.o.o.

EL.OPREMA VERT.SUP.KM TFS TWD

IDENT:

670505

12.6.2008

POZ	IDENT	NAZIV	ENOTA	KOLIČINA
1	608202	KABEL YSLY 21X1,5	MI	8
2	602215	SPONKA VV 12X2,5	KOS	1
3	609836	KABEL YSLY 2X0,75	KOS	3
4	607733	UVODNICA PVC PG 7	KOS	5
5	607757	UVODNICA PVC 16 RAVNA	KOS	2
6	607973	UVODNICA PVC 11 RAVNA	KOS	4
7	609707	TIPKA PREK. SVET.ZELENA ZB4BK1233	KOS	2
8	610276	SENZOR IND. XS1N08PA349	KOS	2
9	610390	SENZOR MAGNETNI MSA-0122 SIKO	KOS	1
10	609657	TIPKA ZB4BD2	KOS	1
11	609920	TIPKA ELE.ZEL. ZB4-BW0B31	KOS	2
12	608612	KABEL YSLY 18X0,75	MI	2
13	608931	LETV AMI-DP 200	KOS	1
14	609819	KONTAKTOR LPIK0910BD	KOS	2
15	602732	UVODNICA PG21 RAVNA	KOS	1
16	609658	ELEMENT ZBE102	KOS	2
17	609659	ELEMENT ZBE101	KOS	6
18	609637	ELEMENT TIPKE ZB4BZ101	KOS	1
19	609743	TIPKA PREKLOPNA RDEČA ZB4BK1243	KOS	1
20	608943	RAZDELILEC PK 9517	KOS	1
21	608982	SPONKA VRSTNA TRO. ABI-ET32 35U	KOS	8
22	608991	SPONKA OZ.ABI-TP435U	KOS	2
23	609091	ČEV PEŠEL PVC FI 16	M	2
24	609093	UVODNICA PG 16 - FI 16	KOS	4
25	610891	PODNOŽJE RELEJA RXZE2M114M	KOS	1
26	610913	NAPISNA PLOŠČICA RXZL420	KOS	1
27	608939	STIKALO ZAŠČITNO GV2-MB14	KOS	1
28	609781	TIPKA-RDEČA ZB4BW0B41	KOS	1
29	608399	KABEL YSLY 7X1	MI	5
30	610370	RELE ABR2S112B	KOS	1
31	610890	RELE RXM4AB2BD	KOS	1
32	610391	DISPLEJ MA561-0001 SIKO	KOS	1



POZ	IDENT	NAZIV	ENOTA	KOLIČINA
1	609359	POTNJIOMETER 1K LTN FI 6	KOS	1
2	608982	SPONKA VRSTNA TRO. ABI-ET32 35U	KOS	3
3	609493	VAROVALKA AVT.GBZCD14	KOS	1
4	609816	PRETVORNIK FREKVENČNI ATV28HU18M2	KOS	1
5	610021	FOTOCELICA XU8B18PP340D	KOS	1
6	610022	KABEL S KONEKTORJEM XZCP1141L5	KOS	1
7	609554	CEV GIBLI ZASČITNA PVC FI 14	M	4
8	609544	UVODNICA PG 13,5 - FI 14	KOS	2
9	609406	CEV GIBLI ZASČITNA PVC FI 10	MI	2
10	609384	UVODNICA PG 9 - FI 10	KOS	1
11	609232	CEV GIBLI ZASČITNA PVC FI 12	MI	6
12	608336	KABEL YSLY 4X1,5	MI	7
13	609430	UVODNICA PG 13,5 - FI 12	KOS	4
14	609055	MOTORNA VTIČNICA 5P 16A VGR.	KOS	1
15	609056	MOTORNI VTIKAC 5P 16A	KOS	1
16	608989	SPONKA ABI-VV435U	KOS	9
17	607659	KONEKTOR HC-B16-EBUS	KOS	1
18	607661	KONEKTOR HC-B16-SMLD/2PG21	KOS	1
19	607662	KONEKTOR HC-B16-TFL/PG21G	KOS	1
20	607660	KONEKTOR HC-B16 ESTS	KOS	1
21	609982	KABEL YSLY 14X1,5	M	4
22	609016	DOZA190-140-70	KOS	1